



Bidirectional, High-Side, Current-Sense Amplifiers with Reference

General Description

The MAX4069–MAX4072 low-cost, bidirectional, high-side, current-sense amplifiers are ideal for monitoring battery charge and discharge currents in notebooks, cell phones, and other portable equipment. They feature up to 24V input common-mode voltage range, low 100 μ A supply current (which drops to only 10 μ A in shutdown), and a total output error of less than 1.5%. The wide 1.35V to 24V input common-mode range is independent of the supply voltage, ensuring that the current-sense feedback remains accurate even when connected to a battery pack in deep discharge.

To achieve maximum flexibility, an external current-sense resistor is used along with a Gain Select pin to choose either 50V/V or 100V/V. A single output pin continuously monitors the transition from charge to discharge and avoids the need for a separate polarity output. The MAX4070 contains an internal 2.5V reference. The charging current is represented by an output voltage from 2.5V to V_{CC} , while discharge current is given from 2.5V to GND. The MAX4071 is similar, but with a reference voltage of 1.5V. The MAX4069 has an adjustable reference voltage, set by two external resistors. The MAX4072 has an input for an external reference.

The MAX4069/MAX4071/MAX4072 operate from a 2.7V to 24V single supply. The MAX4070 operates from a 3.6V to 24V single supply. All devices are specified over the automotive operating temperature range, -40°C to +125°C. The MAX4070/MAX4071/MAX4072 are available in 8-pin μ MAX and 8-pin thin QFN packages. The MAX4069 is available in a 10-pin μ MAX[®] package.

Applications

- Notebook Fuel Gauging
- Smart-Battery Packs/Chargers
- Motor Control
- Power-Management Systems
- Cell-Phone Battery-Current Monitoring

μ MAX is a registered trademark of Maxim Integrated Products, Inc.

Pin Configurations and Selector Guide appear at end of data sheet.



Features

- ◆ Bidirectional, Compact, Current-Sense Solution
- ◆ Total Output Error Less than 1.5%
- ◆ Selectable Gain of 50V/V or 100V/V
- ◆ Wide 1.35V to 24V Common-Mode Range Independent of Supply Voltage
- ◆ 2.7V to 24V Single-Supply Operation
- ◆ Internal Precision Reference
 - Adjustable (MAX4069)
 - 2.50V (MAX4070)
 - 1.50V (MAX4071)
- ◆ Low 100 μ A Supply Current
- ◆ 10 μ A Supply Current in Shutdown
- ◆ Available in Space-Saving Packages
 - 8-Pin Thin QFN (MAX4070/MAX4071/MAX4072)
 - 8-Pin μ MAX (MAX4070/MAX4071/MAX4072)
 - 10-Pin μ MAX (MAX4069)

Ordering Information

PART	TEMP RANGE	PIN-PACKAGE	TOP MARK
MAX4069AUB	-40°C to +125°C	10 μ MAX	—
MAX4070AUA	-40°C to +125°C	8 μ MAX	—
MAX4070ATA	-40°C to +125°C	8 Thin QFN-EP*	ABN
MAX4071AUA	-40°C to +125°C	8 μ MAX	—
MAX4071ATA	-40°C to +125°C	8 Thin QFN-EP*	ABO
MAX4072AUA	-40°C to +125°C	8 μ MAX	—
MAX4072ATA	-40°C to +125°C	8 Thin QFN-EP*	ABP

*EP = Exposed pad.

Typical Operating Circuit

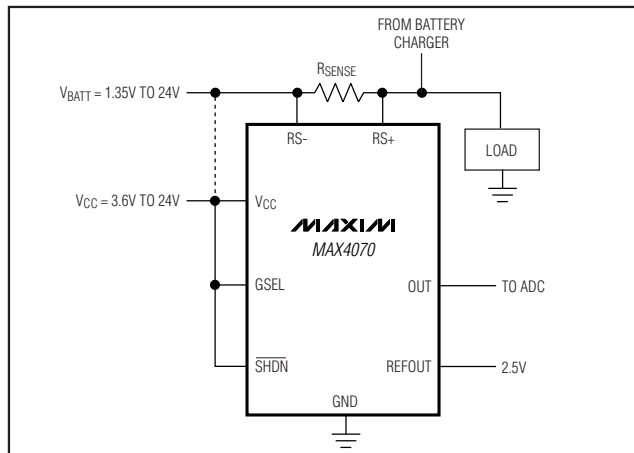

MAX4069–MAX4072

Bidirectional, High-Side, Current-Sense Amplifiers with Reference

ABSOLUTE MAXIMUM RATINGS

V_{CC}, RS₊, RS₋ to GND-0.3V to +26V
 OUT to GND-0.3V to Lesser of (V_{CC} + 0.3V) or 15V
 Differential Input Voltage (V_{RS+} - V_{RS-})±0.3V
 GSEL, SHDN, REFOUT, REFIN
 and ADJ to GND-0.3V to (V_{CC} + 0.3V)
 OUT Short-Circuit Duration to GND
 or to Lesser of (V_{CC} or 15V)Continuous
 REFOUT Short Circuit to V_{CC} or GNDContinuous
 Current into Any Pin±20mA

Continuous Power Dissipation (T_A = +70°C)
 8-Pin μMAX (derate 4.5 mW/°C above +70°C)362mW
 8-Pin Thin QFN (derate 24.4mW/°C above +70°C) ...1951mW
 10-Pin μMAX (derate 5.6 mW/°C above +70°C)444.4mW
 Operating Temperature Range-40°C to +125°C
 Junction Temperature+150°C
 Storage Temperature Range-65°C to +150°C
 Lead Temperature (soldering, 10s)+300°C

Stresses beyond those listed under "Absolute Maximum Ratings" may cause permanent damage to the device. These are stress ratings only, and functional operation of the device at these or any other conditions beyond those indicated in the operational sections of the specifications is not implied. Exposure to absolute maximum rating conditions for extended periods may affect device reliability.

ELECTRICAL CHARACTERISTICS

(V_{RS+} = V_{RS-} = V_{CC} = 2.7V to 24V, V_{SENSE} = V_{RS+} - V_{RS-} = 0V, I_{REFOUT} = 0, V_{SHDN} = V_{CC}, V_{GSEL} = GND, V_{REFIN} = 2.5V (MAX4072), T_A = T_{MIN} to T_{MAX}, unless otherwise noted. Typical values are at T_A = +25°C and at V_{CC} = V_{RS+} = 12V.) (Notes 1, 2)

PARAMETER	SYMBOL	CONDITIONS	MIN	TYP	MAX	UNITS
Operating Voltage Range (Note 3)	V _{CC}	MAX4069/MAX4071/MAX4072 (Note 4)	2.7		24	V
		MAX4070	3.6		24	
Input-Referred Offset Voltage (Note 5)	V _{OS}	V _{CC} = V _{RS+} = V _{RS-} = 12V	T _A = +25°C	0.08	0.25	mV
			T _A = -40°C to +85°C		0.8	
			T _A = T _{MIN} to T _{MAX}		1	
Common-Mode Input Range	CMVR	Guaranteed by CMRR test	1.35		24	V
Common-Mode Rejection Ratio	CMRR	1.35V ≤ V _{RS+} = V _{RS-} ≤ 24V, V _{CC} = 12V	100	120		dB
Supply Current	I _{CC}	V _{CC} = V _{RS+} = V _{RS-} = 24V, R _L = open, T _A = T _{MIN} to T _{MAX}		100	250	μA
Shutdown Supply Current	I _{CC SHDN}	V _{CC} = V _{RS+} = V _{RS-} = 5.5V, SHDN = GND, T _A = +25°C		9		μA
		V _{CC} = V _{RS+} = V _{RS-} = 24V, SHDN = GND		10	30	
Leakage Current		V _{RS+} = V _{RS-} = 24V, V _{CC} = 0V		0.1	0.5	μA
Input Bias Current	I _{RS+} , I _{RS-}	V _{CC} = V _{RS+} = V _{RS-} = 24V	0	2.4	5	μA
Recommended Full-Scale Sense Voltage (Note 6)	V _{SENSE}	Gain = 50V/V		75		mV
		Gain = 100V/V		50		

Bidirectional, High-Side, Current-Sense Amplifiers with Reference

MAX4069-MAX4072

ELECTRICAL CHARACTERISTICS (continued)

($V_{RS+} = V_{RS-} = V_{CC} = 2.7V$ to $24V$, $V_{SENSE} = V_{RS+} - V_{RS-} = 0V$, $I_{REFOUT} = 0$, $V_{SHDN} = V_{CC}$, $V_{GSEL} = GND$, $V_{REFIN} = 2.5V$ (MAX4072), $T_A = T_{MIN}$ to T_{MAX} , unless otherwise noted. Typical values are at $T_A = +25^{\circ}C$ and at $V_{CC} = V_{RS+} = 12V$.) (Notes 1, 2)

PARAMETER	SYMBOL	CONDITIONS	MIN	TYP	MAX	UNITS
Total OUT Voltage Error (Note 7)		$V_{SENSE} = 75mV$, $V_{CC} = V_{RS+} = 12V$, gain = 50	$T_A = +25^{\circ}C$	± 0.25	± 1.0	%
			$T_A = -40^{\circ}C$ to $+85^{\circ}C$		± 1.5	
			$T_A = T_{MIN}$ to T_{MAX}		± 2.0	
		$V_{SENSE} = 50mV$, $V_{CC} = V_{RS+} = 12V$, gain = 100	$T_A = +25^{\circ}C$	± 0.25	± 1.0	
			$T_A = -40^{\circ}C$ to $+85^{\circ}C$		± 1.5	
			$T_A = T_{MIN}$ to T_{MAX}		± 2.5	
		MAX4069/MAX4070/ MAX4072: $V_{SENSE} = -35mV$, $V_{CC} = V_{RS+} = 12V$, gain = 50	$T_A = +25^{\circ}C$	± 0.4	± 1.0	
			$T_A = -40^{\circ}C$ to $+85^{\circ}C$		± 2.0	
			$T_A = T_{MIN}$ to T_{MAX}		± 3.0	
		MAX4069/MAX4070/ MAX4072: $V_{SENSE} = -17.5mV$, $V_{CC} = V_{RS+} = 12V$, gain = 100	$T_A = +25^{\circ}C$	± 0.8	± 2.0	
			$T_A = -40^{\circ}C$ to $+85^{\circ}C$		± 4.0	
			$T_A = T_{MIN}$ to T_{MAX}		± 6	
		MAX4071: $V_{SENSE} = -15mV$, $V_{CC} = V_{RS+} = 12V$, gain = 50	$T_A = +25^{\circ}C$	± 1.0	± 2.5	
			$T_A = -40^{\circ}C$ to $+85^{\circ}C$		± 4.0	
			$T_A = T_{MIN}$ to T_{MAX}		± 6.0	
MAX4071: $V_{SENSE} = -7.5mV$, $V_{CC} = V_{RS+} = 12V$, gain = 100	$T_A = +25^{\circ}C$	± 2.0	± 5			
	$T_A = -40^{\circ}C$ to $+85^{\circ}C$		± 10			
	$T_A = T_{MIN}$ to T_{MAX}		± 15			
$V_{SENSE} = 3mV$, $V_{CC} = 12V$, $V_{RS+} = 12V$	$T_A = +25^{\circ}C$	± 3				

Bidirectional, High-Side, Current-Sense Amplifiers with Reference

ELECTRICAL CHARACTERISTICS (continued)

($V_{RS+} = V_{RS-} = V_{CC} = 2.7V$ to $24V$, $V_{SENSE} = V_{RS+} - V_{RS-} = 0V$, $I_{REFOUT} = 0$, $\overline{V_{SHDN}} = V_{CC}$, $V_{GSEL} = GND$, $V_{REFIN} = 2.5V$ (MAX4072), $T_A = T_{MIN}$ to T_{MAX} , unless otherwise noted. Typical values are at $T_A = +25^{\circ}C$ and at $V_{CC} = V_{RS+} = 12V$.) (Notes 1, 2)

PARAMETER	SYMBOL	CONDITIONS		MIN	TYP	MAX	UNITS
OUT Voltage High	$V_{CC} - V_{OH}$	$I_{OUT} = 10\mu A$, $V_{SENSE} = 100mV$, $V_{RS+} = V_{CC}$	MAX4071, $V_{CC} = 2.7V$	65	150	mV	
			MAX4069/MAX4070/ MAX4072, $V_{CC} = 3.6V$	65	150		
		$I_{OUT} = 500\mu A$, $V_{SENSE} = 100mV$, $V_{RS+} = V_{CC}$	MAX4071, $V_{CC} = 2.7V$	90	250		
			MAX4069/MAX4070/ MAX4072, $V_{CC} = 3.6V$	90	250		
OUT Voltage Low	V_{OL}	$I_{OUT} = -10\mu A$, $V_{SENSE} = -100mV$, $V_{RS+} = V_{CC}$	MAX4071, $V_{CC} = 2.7V$	5	20	mV	
			MAX4069/MAX4070/ MAX4072, $V_{CC} = 3.6V$	5	20		
		$I_{OUT} = -500\mu A$, $V_{SENSE} = -100mV$, $V_{RS+} = V_{CC}$	MAX4071, $V_{CC} = 2.7V$	100	250		
			MAX4069/MAX4070/ MAX4072, $V_{CC} = 3.6V$	100	250		
-3dB Bandwidth	BW	$V_{SENSE} = 50mV$, $V_{CC} = 12V$, $C_L = 100pF$	Gain = 50V/V	100		kHz	
			Gain = 100V/V	40			
Gain	A_V	GSEL = GND		50		V/V	
			GSEL = V_{CC}		100		
Capacitive-Load Stability				100		pF	
Power-Supply Rejection Ratio	PSRR	$V_{CC} = 2.7V$ to $24V$ (MAX4069/MAX4071/MAX4072), $V_{CC} = 3.6V$ to $24V$ (MAX4070)		100	120		dB
Logic Low Voltage (GSEL, \overline{SHDN})	V_{IL}	$V_{CC} = 3.6V$ or $24V$				0.6	V
Logic High Voltage (GSEL, \overline{SHDN})	V_{IH}	$V_{CC} = 3.6V$ or $24V$		2			V
Gain-Select Input Current	I_{GSEL}	GSEL = $V_{CC} = 24V$ or GND		0.01	1		μA
Shutdown Input Current	$I_{\overline{SHDN}}$	$\overline{SHDN} = V_{CC} = 24V$		3	12		μA
		$\overline{SHDN} = GND$, $V_{CC} = 24V$		0.01	1		

Bidirectional, High-Side, Current-Sense Amplifiers with Reference

MAX4069-MAX4072

ELECTRICAL CHARACTERISTICS (continued)

($V_{RS+} = V_{RS-} = V_{CC} = 2.7V$ to $24V$, $V_{SENSE} = V_{RS+} - V_{RS-} = 0V$, $I_{REFOUT} = 0$, $V_{SHDN} = V_{CC}$, $V_{GSEL} = GND$, $V_{REFIN} = 2.5V$ (MAX4072), $T_A = T_{MIN}$ to T_{MAX} , unless otherwise noted. Typical values are at $T_A = +25^{\circ}C$ and at $V_{CC} = V_{RS+} = 12V$.) (Notes 1, 2)

PARAMETER	SYMBOL	CONDITIONS	MIN	TYP	MAX	UNITS	
REFOUT (MAX4069/MAX4070/MAX4071)							
Reference Output Voltage	V_{REF}	MAX4069, $V_{CC} = 12V$ (Note 2)	$T_A = +25^{\circ}C$	2.44	2.49	2.54	V
			$T_A = T_{MIN}$ to T_{MAX}	2.39		2.59	
		MAX4070, $V_{CC} = 12V$	$T_A = +25^{\circ}C$	2.45	2.5	2.55	
			$T_A = T_{MIN}$ to T_{MAX}	2.40		2.60	
		MAX4071, $V_{CC} = 12V$	$T_A = +25^{\circ}C$	1.47	1.5	1.53	
			$T_A = T_{MIN}$ to T_{MAX}	1.44		1.56	
Reference Output Voltage Temperature Coefficient	TCV_{REF}	$V_{CC} = 12V$	$-40^{\circ}C \leq T_A \leq +85^{\circ}C$		15	ppm/ $^{\circ}C$	
			$T_A = T_{MIN}$ to T_{MAX}		20		
Load Regulation	$\Delta V_{REFOUT} / \Delta I_{REF}$	$I_{REFOUT} = 0$ to $500\mu A$ $I_{REFOUT} = 0$ to $-100\mu A$		2		mV/mA	
				4			
Line Regulation	$\Delta V_{REF} / \Delta V_{CC}$	$2.7V \leq V_{CC} \leq 24V$		20		$\mu V/V$	
REF Capacitive-Load Stability				500		pF	
Reference Adjust Voltage Threshold	V_{ADJ}	MAX4069, $V_{CC} = 12V$		1.230		V	
Reference Output Voltage Range		MAX4069, range adjustable with R1 and R2, $V_{CC} = 12V$		V_{ADJ} to +4		V	
Reference Adjust Input Current	I_{ADJ}	MAX4069, $V_{CC} = 12V$, $V_{ADJ} = 1.23V$		100		nA	
REFIN (MAX4072 only)							
Input-Voltage Range		$V_{CC} = 12V$	1		4	V	
Input Current		$REFIN = 2.5V$, $V_{CC} = 12V$	-60		+20	μA	

Note 1: All devices are 100% tested at $T_A = +25^{\circ}C$. Limits over temperature are guaranteed by design.

Note 2: $R1 = 215k\Omega$, $R2 = 210k\Omega$ for the MAX4069 only (see *Functional Diagram*). This sets REFOUT to 2.49V nominal.

Note 3: Guaranteed by the PSRR test.

Note 4: The REFOUT voltage for the MAX4069 should be set such that it does not exceed $V_{CC} - 1.1V$. Similarly, the maximum REFIN voltage for the MAX4072 should also be less than $V_{CC} - 1.1V$.

Note 5: Input-Referred Offset Voltage is defined as the voltage difference between OUT and REFOUT, divided by the selected gain of either 50 or 100, when $V_{SENSE} = V_{RS+} - V_{RS-} = 0V$.

Note 6: The negative full-scale sense voltage is limited by the voltage range of OUT from V_{REFOUT} to GND.

Note 7: Total OUT Voltage Error is the sum of offset voltage and gain errors. The output voltage is measured relative to the reference (REFOUT or REFIN).

Bidirectional, High-Side, Current-Sense Amplifiers with Reference

Typical Operating Characteristics

($V_{CC} = V_{RS+} = 12V$, $V_{SENSE} = 50mV$ for gain of 100V/V and 75mV for gain of 50V/V, $T_A = +25^{\circ}C$, unless otherwise noted.)

INPUT OFFSET VOLTAGE DISTRIBUTION

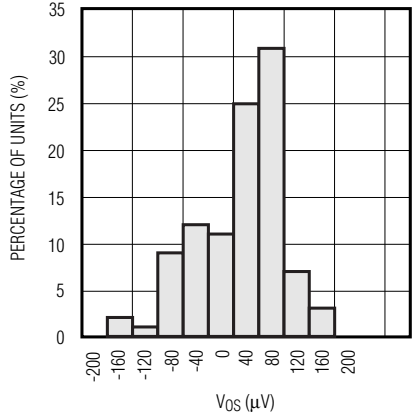

INPUT OFFSET VOLTAGE vs. TEMPERATURE

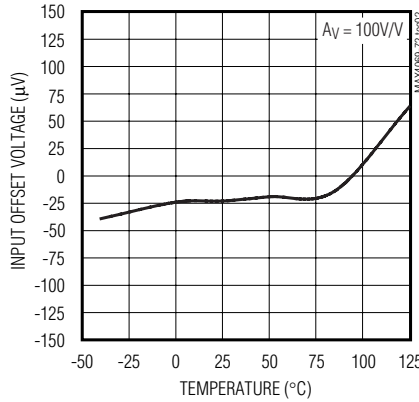

(VOUT - VREF) vs. VSENSE

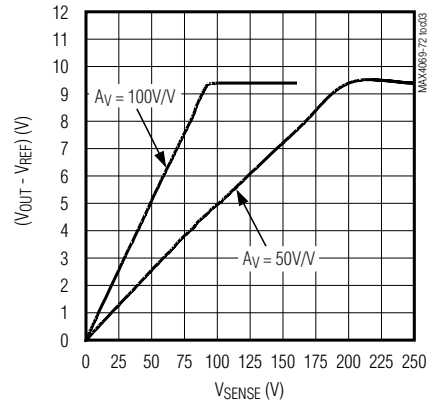

TOTAL ERROR vs. SUPPLY VOLTAGE

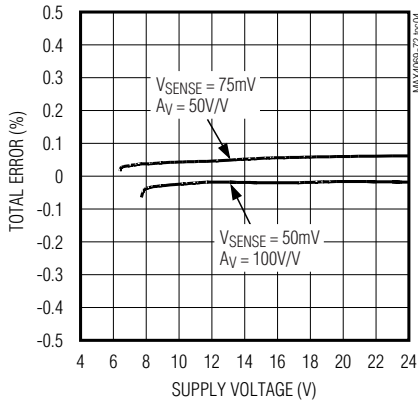

TOTAL ERROR vs. SUPPLY VOLTAGE (VSENSE = 3mV)

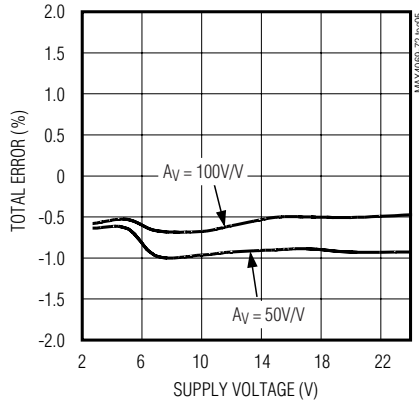

TOTAL ERROR vs. TEMPERATURE

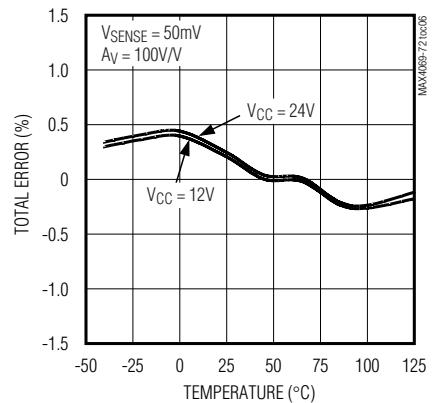

SUPPLY CURRENT vs. SUPPLY VOLTAGE

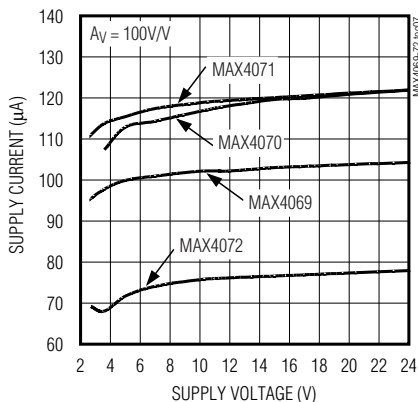

SUPPLY CURRENT vs. TEMPERATURE

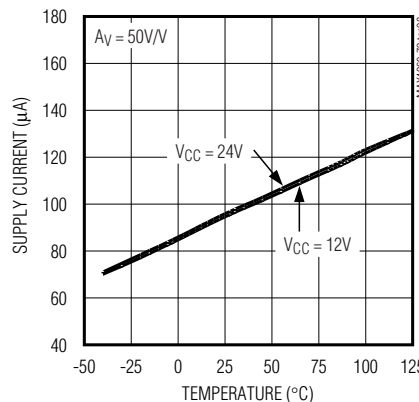

MAX4069 REFOUT vs. TEMPERATURE

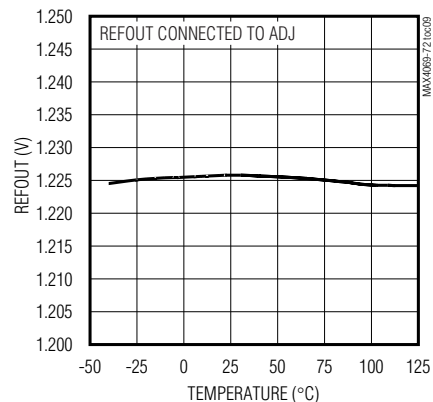

Bidirectional, High-Side, Current-Sense Amplifiers with Reference

MAX4069-MAX4072

Typical Operating Characteristics (continued)

($V_{CC} = V_{RS+} = 12V$, $V_{SENSE} = 50mV$ for gain of 100V/V and 75mV for gain of 50V/V, $T_A = +25^\circ C$, unless otherwise noted.)

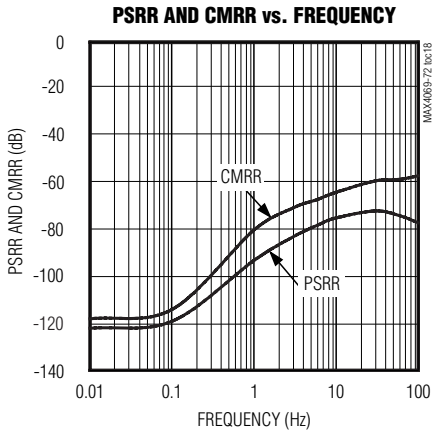
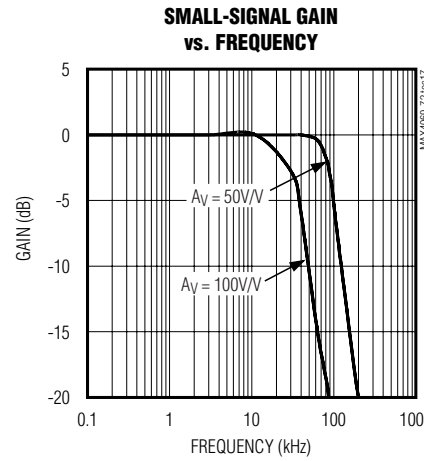
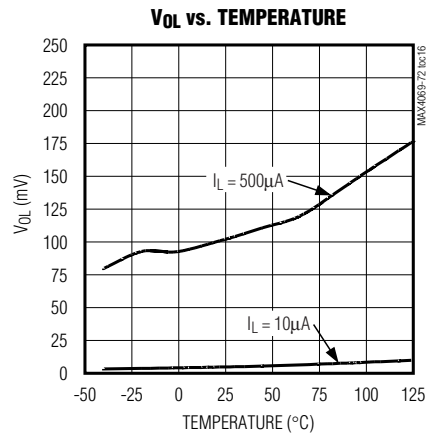
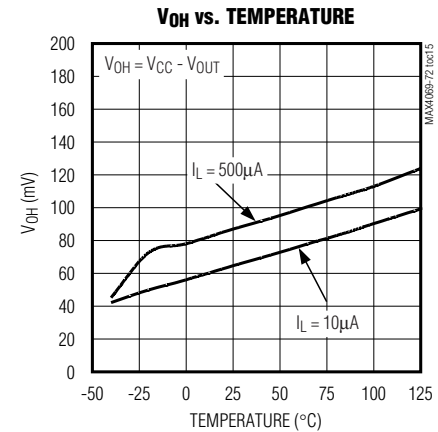
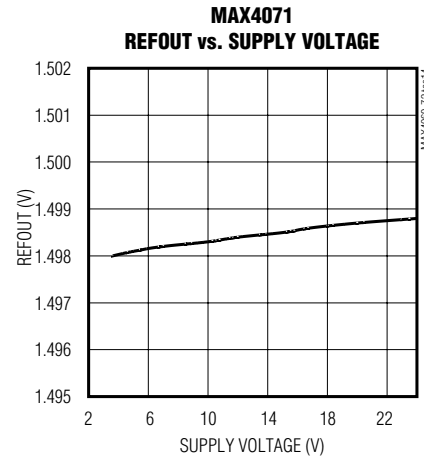
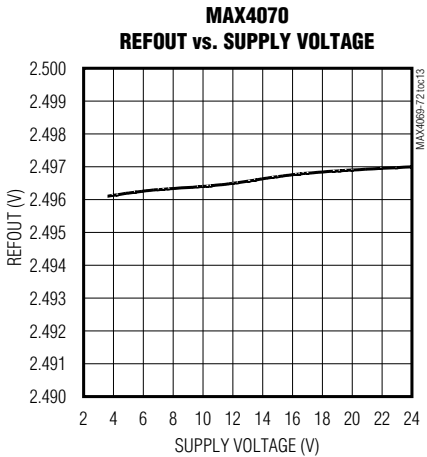
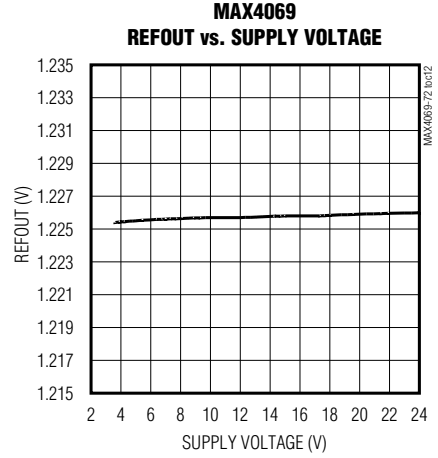
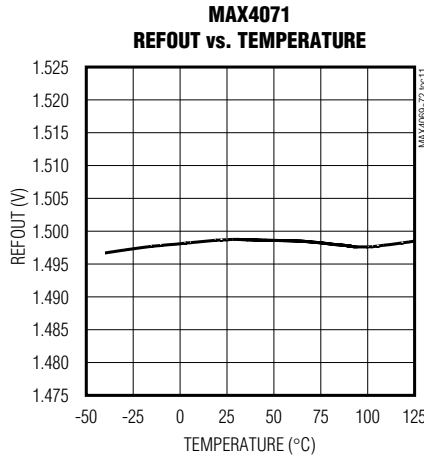
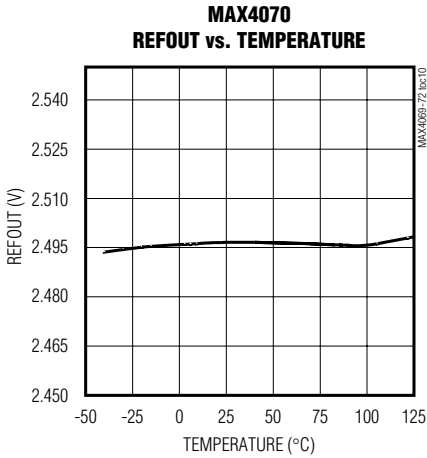

Bidirectional, High-Side, Current-Sense Amplifiers with Reference

Typical Operating Characteristics (continued)

($V_{CC} = V_{RS+} = 12V$, $V_{SENSE} = 50mV$ for gain of 100V/V and 75mV for gain of 50V/V, $T_A = +25^{\circ}C$, unless otherwise noted.)

SMALL-SIGNAL TRANSIENT RESPONSE

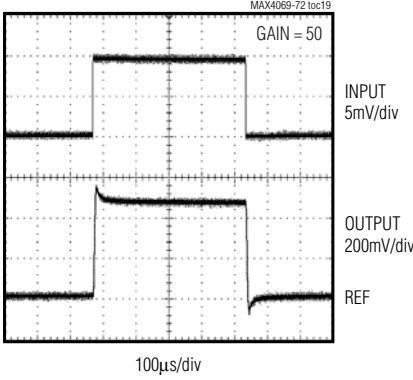

SMALL-SIGNAL TRANSIENT RESPONSE

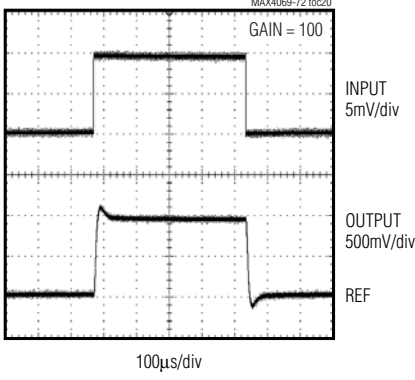

LARGE-SIGNAL TRANSIENT RESPONSE

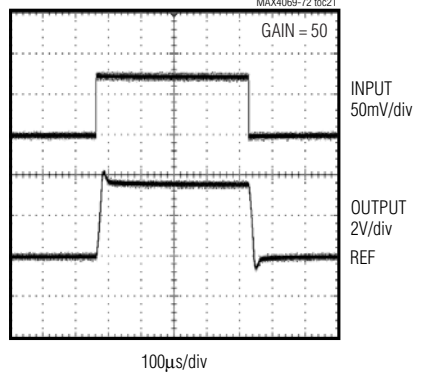

LARGE-SIGNAL TRANSIENT RESPONSE

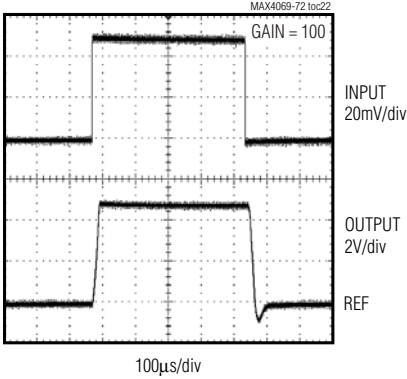

STARTUP DELAY

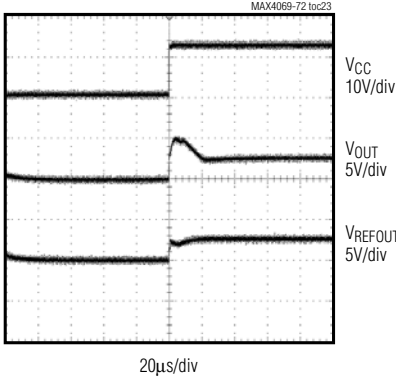

EXITING SHUTDOWN

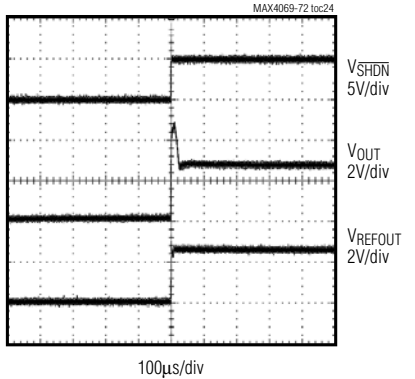

Bidirectional, High-Side, Current-Sense Amplifiers with Reference

Pin Description

PIN			NAME	FUNCTION
MAX4069	MAX4070/ MAX4071	MAX4072		
1	1	1	$\overline{\text{SHDN}}$	Shutdown Input. Drive $\overline{\text{SHDN}}$ low to select shutdown mode. Connect $\overline{\text{SHDN}}$ to V_{CC} for normal operation.
2	2	2	RS-	Negative Connection to the External Sense Resistor
3	3	3	RS+	Positive Connection to the External Sense Resistor
4	—	—	N.C.	No Connection. Not internally connected.
5	4	4	GND	Ground. For thin QFN packages, also make an external connection from GND to the under-side exposed paddle.
6	—	—	ADJ	Adjustable Output Voltage Feedback Input. Connect a resistor-divider between REFOUT, ADJ, and GND (MAX4069 only, see <i>Functional Diagram</i>).
7	5	—	REFOUT	Reference Output Voltage (MAX4069/MAX4070/MAX4071)
8	6	6	OUT	Voltage Output. The difference voltage, $V_{OUT} - V_{REF}$, is proportional to the voltage difference between RS+ and RS- and indicates the correct polarity.
9	7	7	V_{CC}	Supply Voltage Input. Bypass V_{CC} to GND with a 0.1 μ F capacitor.
10	8	8	GSEL	Gain-Setting Input. Connect GSEL low to select gain = 50V/V, or connect GSEL high to select gain = 100V/V.
—	—	5	REFIN	Reference Input Voltage (MAX4072)

MAX4069-MAX4072

Functional Diagram

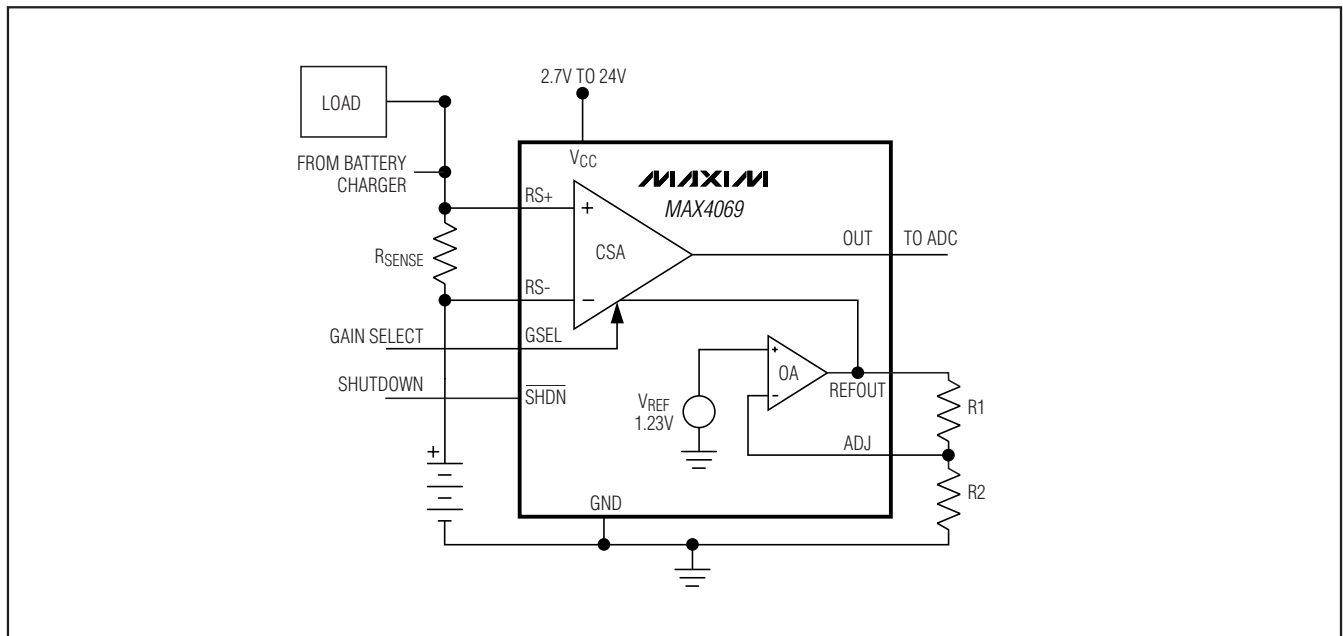

Bidirectional, High-Side, Current-Sense Amplifiers with Reference

Detailed Description

The MAX4069–MAX4072 bidirectional, high-side, current-sense amplifiers are ideal for portable equipment. The wide 1.35V to 24V input common-mode voltage range is independent of the supply voltage, ensuring that the current-sense feedback remains accurate even when connected to a battery pack in deep discharge.

The MAX4069/MAX4071/MAX4072 operate from a 2.7V to 24V single supply. Because the MAX4070 has a 2.5V internal reference, it operates from 3.6V to 24V. All devices have a low 100 μ A supply current that reduces to only 10 μ A (typ) in shutdown mode. To achieve maximum flexibility, an external current-sense resistor is used along with a gain select pin (GSEL) to choose either 50V/V or 100V/V. Drive GSEL low to select gain of 50V/V or drive GSEL high to choose gain of 100V/V (see *Functional Diagram*). The MAX4069 has an adjustable reference voltage set by two external resistors between REFOUT and ADJ, and GND pins. The MAX4070 contains an internal 2.5V reference. The MAX4071 is similar to the MAX4070 but with a fixed internal reference voltage of 1.5V. The MAX4072 has a reference input pin to allow use of external references. Charging current is represented by an output voltage from the reference voltage to V_{CC} , while discharge current is given from the reference voltage to GND. The direction of V_{SENSE} is totally arbitrary.

The input stage of the MAX4069–MAX4072 is shown in Figure 1. Its unique topology allows for monitoring bidirectional currents through the sense resistor (R_{SENSE}). If, for instance, current flows from $RS+$ to $RS-$, the MAX4069–MAX4072 match for the voltage drop over the external sense resistor (R_{SENSE}) by increasing the current through the internal Q1 and RG1. At the same time, the current through Q2 and RG2 decreases, however, internal circuitry not shown in Figure 1 prevents Q2 from turning off completely. Likewise, if current flows from $RS-$ to $RS+$, the current through Q2 and RG2 increases and the current through Q1 decreases. In this way, the voltages at the input terminals of the internal amplifier A1 are kept constant and an accurate measurement of the sense voltage is achieved. In the following amplifier stages of the MAX4069–MAX4072, the output signal of amplifier A2 is level-shifted towards the reference voltage (V_{REF}), resulting in a voltage at the output pin (OUT) that swings above the V_{REF} voltage for positive-sense voltages and below V_{REF} for negative-sense voltages.

Note: $R_{G1} = R_{G2} = 104k$ (typ).

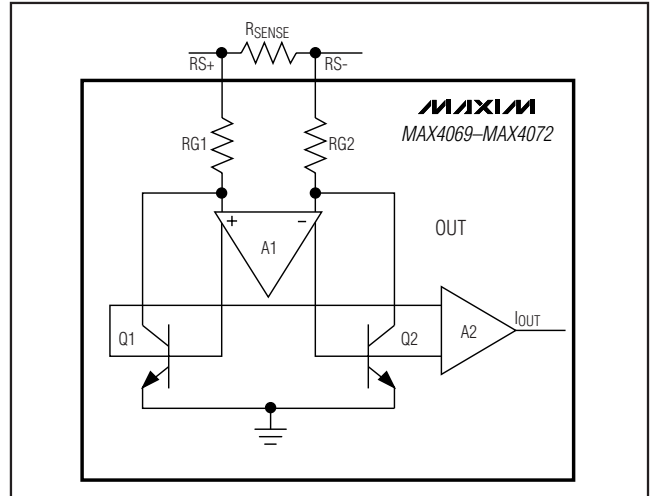

Figure 1. Detailed Input Stage

Applications Information

Bidirectional, Current-Sense Amplifier

Systems such as laptop computers and other devices that have internal charge circuitry require a precise bidirectional, current-sense amplifier to accurately monitor the battery's current regardless of polarity. Figure 2 shows the MAX4069–MAX4072 used as a bidirectional current monitor. In Figure 2, the direction of V_{SENSE} is assigned to charge and discharge, assuming charge is greater than discharge. The practical choice of direction is based on dynamic range at OUT, given that the range of REF to V_{CC} is usually greater than from REF to ground. This is useful for implementing either smart battery packs or fuel gauges.

High-Current Measurement

The MAX4069–MAX4072 can achieve high-current measurements by using low-value sense resistors, which can be paralleled to further increase the current-sense limit.

Adjusting V_{REF} (MAX4069)

The MAX4069 has an output reference voltage that can be set to a desired voltage by a two-resistor divider between REFOUT, ADJ, and GND. If REFOUT and ADJ are connected together, the minimum output reference voltage is obtained, 1.23V (typ). The maximum voltage for REFOUT is 4V (that requires $V_{CC} \geq 5.1V$). The recommended range for the external resistors is: $R1 + R2$ should be $> 20k\Omega$ and $< 500k\Omega$.

Bidirectional, High-Side, Current-Sense Amplifiers with Reference

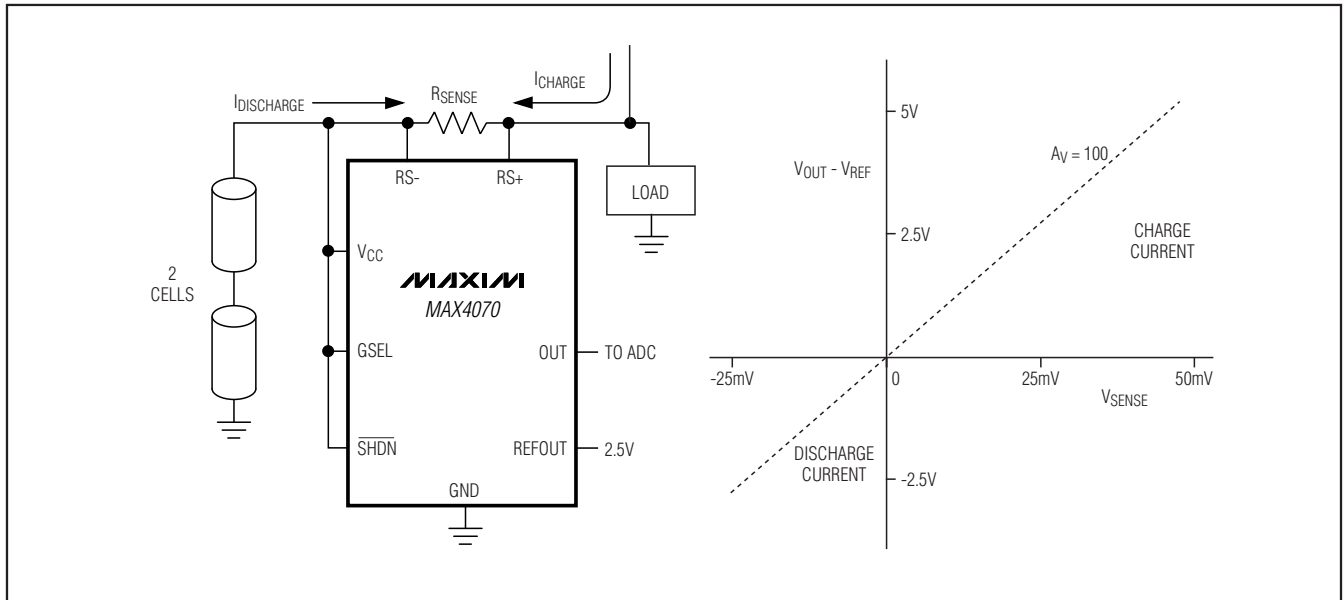

Figure 2. Bidirectional Current Monitor

External Reference (MAX4072)

The MAX4072 contains REFIN pin for external reference voltage. The allowable voltage range on REFIN is 1V (min) to 4V (max) with $V_{CC} \geq 5.1V$.

Reference Output (MAX4069/MAX4060/MAX4071)

The REFOUT of the MAX4069/MAX4070/MAX4071 can sink $100\mu A$ and source $500\mu A$. Keep the total capacitance on REFOUT under $500pF$ to maintain stability.

Recommended Component Values

Ideally, the maximum load current develops the full-scale sense voltage across the current-sense resistor. Choose the gain needed to yield the maximum output voltage required for the application:

$$V_{OUT} = V_{SENSE} \times A_V$$

where V_{SENSE} is the full-scale sense voltage, $75mV$ for gain of $50V/V$, or $50mV$ for gain of $100V/V$. A_V is the gain of the device.

In applications monitoring high current, ensure that R_{SENSE} is able to dissipate its own I^2R loss. If the resistor's power dissipation is exceeded, its value may drift or it may fail altogether, causing a differential voltage across the terminals in excess of the absolute maximum ratings. Use resistors specified for current-sensing applications.

The MAX4069–MAX4072 sense a wide variety of currents with different sense-resistor values. Table 1 lists common resistor values for typical operation of these devices. Listed output voltage is with respect to REF.

Sense Resistor, R_{SENSE}

Choose R_{SENSE} based on the following criteria:

Voltage Loss: A high R_{SENSE} value causes the power-source voltage to degrade through IR loss. For minimal voltage loss, use the lowest R_{SENSE} value.

Accuracy: A high R_{SENSE} value allows lower currents to be measured more accurately. This is because offsets become less significant when the sense voltage is larger. For best performance, select R_{SENSE} to provide approximately $75mV$ (gain of $50V/V$) or $50mV$ (gain of $100V/V$) of sense voltage for the full-scale current in each application.

Efficiency and Power Dissipation: At high-current levels, the I^2R losses in R_{SENSE} can be significant. Take this into consideration when choosing the resistor value and its power dissipation (wattage) rating. Also, the sense resistor's value might drift if it is allowed to heat up excessively.

Inductance: Keep inductance low if I_{SENSE} has a large high-frequency component. Wire-wound resistors have the highest inductance, while metal film is somewhat better. Low-inductance metal-film resistors are also available. Instead of being spiral-wrapped round a

Bidirectional, High-Side, Current-Sense Amplifiers with Reference

Table 1. Recommended Component Values

FULL-SCALE CURRENT (A)	CURRENT-SENSE RESISTOR (mΩ)	GAIN (V/V)	V _{SENSE} (mV)	FULL-SCALE OUTPUT VOLTAGE WITH RESPECT TO REF (V)
0.075	1000	50	75	3.75
0.05		100	50	5.0
0.75	100	50	75	3.75
0.5		100	50	5.0
3.75	20	50	75	3.75
2.5		100	50	5.0
7.5	10	50	75	3.75
5.0		100	50	5.0
15.0	5	50	75	3.75
10.0		100	50	5.0

core, as in metal-film or wire-wound resistors, they are a straight band of metal and are available in values under 1Ω.

Peak Current: The maximum current through R_{SENSE} must be limited to:

$$I_{PEAK} = 0.3V / (R_{SENSE} + R_{TRACE})$$

where R_{TRACE} is the total stray resistance from RS+ and RS- to R_{SENSE}. To prevent forwarding the back-to-back diodes between the differential input, the absolute maximum of the differential input voltage is 0.3V.

Dynamic Range Considerations

Although the MAX4069–MAX4072 have fully symmetrical, bidirectional, V_{SENSE} input capability, the output-voltage range is usually higher from REF to V_{CC} and lower from REF to GND (unless the supply voltage is at the lowest end of the operating range). Therefore, the user must consider the dynamic range of current monitored in both directions and choose the supply voltage and the reference voltage (REF_{OUT} or REF_{IN}) to make sure the output swing above and below REF is adequate to handle the swings without clipping or running out of headroom.

Shutdown Mode

When \overline{SHDN} is low, the MAX4069–MAX4072 are shut down and consume only 10μA. In shutdown mode, OUT is high impedance and turns off. Connect \overline{SHDN} to V_{CC} for normal operation.

Power-Supply Bypassing and Grounding

The MAX4069–MAX4072 do not require special bypassing and respond quickly to transient changes in line current. You can place a large capacitor at the RS-terminal (or “load” side) to decouple the load and, thereby, reduce the current transients. These capacitors are not required for operation or stability and their use does not degrade performance.

The MAX4069–MAX4072 have been designed as a high-side current monitor to ease the task of grounding any battery charger, thermistor, etc., that may be a part of the battery pack. Grounding these devices requires no special precautions; follow the same cautionary steps that apply to the system as a whole. High-current systems can experience large voltage drops across a ground plane, and this drop may add to or subtract from V_{OUT}. Using differential measurement between V_{OUT} and REF prevents this problem. For highest current-measurement accuracy, use a single-point star ground.

On thin QFN packages, there is an exposed paddle that does not carry any current, but should also be connected to the ground plane for rated power dissipation.

Bidirectional, High-Side, Current-Sense Amplifiers with Reference

Pin Configurations

MAX4069-MAX4072

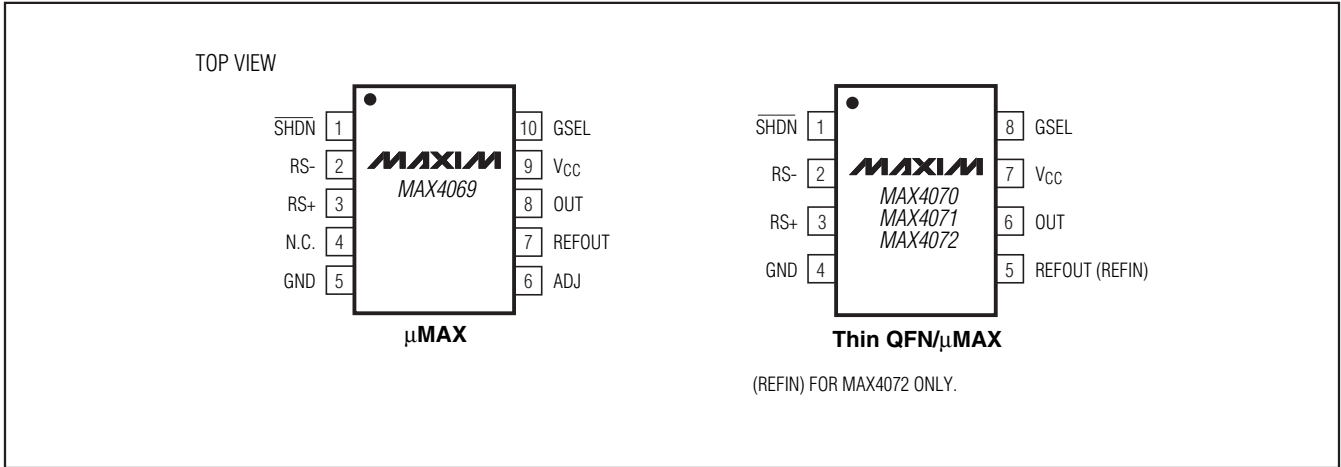

Layout

In order to dissipate sense-resistor heat from large sense currents, solder the RS+ and the RS- pins to large copper traces. Keep the part away from other heat-generating devices.

For accurate measurement of V_{SENSE}, the Kelvin method is recommended. The current into RS+ and RS- is only a few microamps; therefore, a short distance from RS+ and RS- pins does not cause significant errors. It is recommended to keep the value of R_{SENSE} reasonably higher than the values of the trace's resistance.

Selector Guide

PART	REFERENCE	SUPPLY VOLTAGE RANGE (V)	COMMON-MODE RANGE (V)
MAX4069	ADJUSTABLE	2.7 to 24	1.35 to 24
MAX4070	2.5V	3.6 to 24	1.35 to 24
MAX4071	1.5V	2.7 to 24	1.35 to 24
MAX4072	EXTERNAL	2.7 to 24	1.35 to 24

Chip Information

TRANSISTOR COUNT: 338

PROCESS: BiCMOS

Bidirectional, High-Side, Current-Sense Amplifiers with Reference

Package Information

For the latest package outline information and land patterns, go to www.maxim-ic.com/packages.

PACKAGE TYPE	PACKAGE CODE	DOCUMENT NO.
8 TQFN-EP	T833-2	21-0137
8 μ MAX	U8-1	21-0036
10 μ MAX	U10-2	21-0061

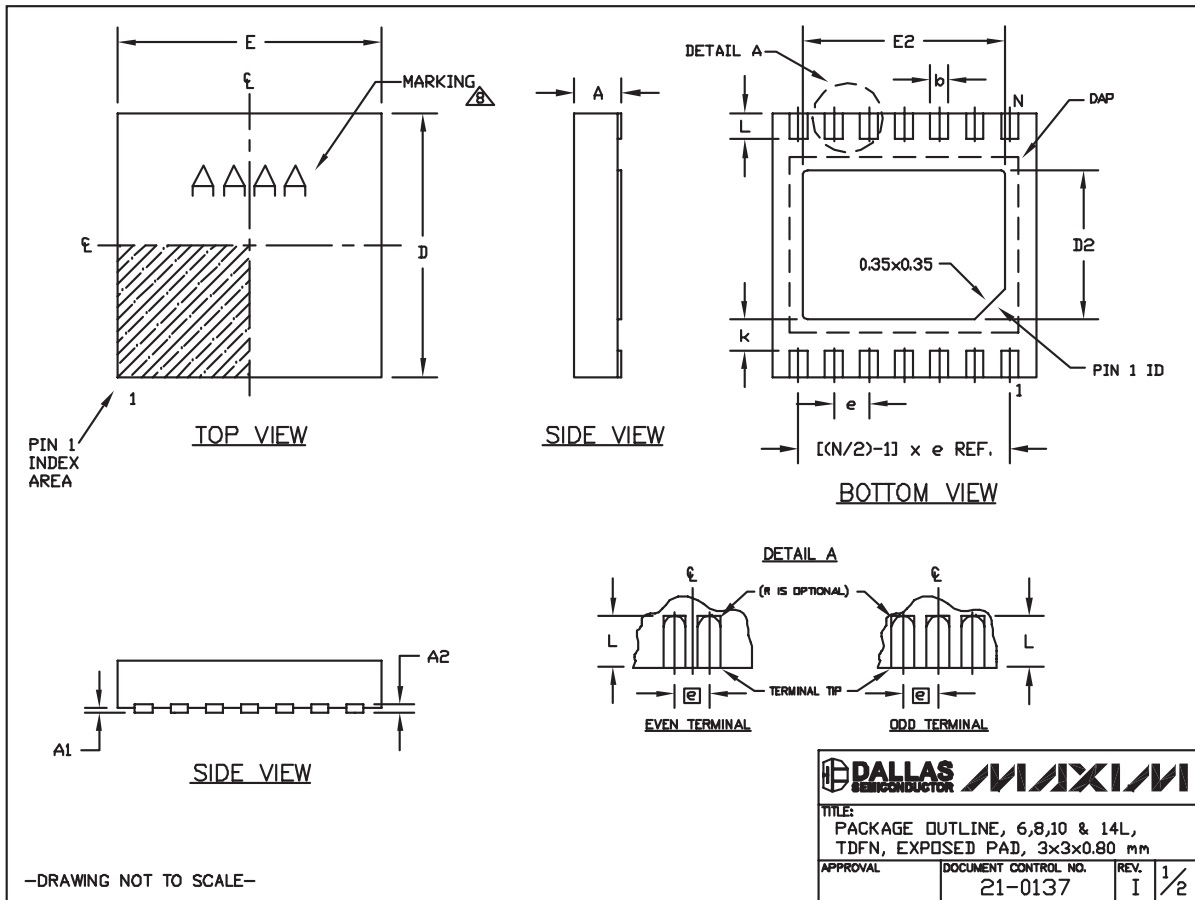

Bidirectional, High-Side, Current-Sense Amplifiers with Reference

Package Information (continued)

For the latest package outline information and land patterns, go to www.maxim-ic.com/packages.

MAX4069-MAX4072

COMMON DIMENSIONS			PACKAGE VARIATIONS							
SYMBOL	MIN.	MAX.	PKG. CODE	N	D2	E2	e	JEDEC SPEC	b	[(N/2)-1] x e
A	0.70	0.80	T633-2	6	1.50±0.10	2.30±0.10	0.95 BSC	MO229 / WEEA	0.40±0.05	1.90 REF
D	2.90	3.10	T833-2	8	1.50±0.10	2.30±0.10	0.65 BSC	MO229 / WEEC	0.30±0.05	1.95 REF
E	2.90	3.10	T833-3	8	1.50±0.10	2.30±0.10	0.65 BSC	MO229 / WEEC	0.30±0.05	1.95 REF
A1	0.00	0.05	T1033-1	10	1.50±0.10	2.30±0.10	0.50 BSC	MO229 / WEED-3	0.25±0.05	2.00 REF
L	0.20	0.40	T1033-2	10	1.50±0.10	2.30±0.10	0.50 BSC	MO229 / WEED-3	0.25±0.05	2.00 REF
k	0.25 MIN.		T1433-1	14	1.70±0.10	2.30±0.10	0.40 BSC	----	0.20±0.05	2.40 REF
A2	0.20 REF.		T1433-2	14	1.70±0.10	2.30±0.10	0.40 BSC	----	0.20±0.05	2.40 REF

NOTES:

1. ALL DIMENSIONS ARE IN mm. ANGLES IN DEGREES.
2. COPLANARITY SHALL NOT EXCEED 0.08 mm.
3. WARPAGE SHALL NOT EXCEED 0.10 mm.
4. PACKAGE LENGTH/PACKAGE WIDTH ARE CONSIDERED AS SPECIAL CHARACTERISTIC(S).
5. DRAWING CONFORMS TO JEDEC MO229, EXCEPT DIMENSIONS "D2" AND "E2", AND T1433-1 & T1433-2.
6. "N" IS THE TOTAL NUMBER OF LEADS.
7. NUMBER OF LEADS SHOWN ARE FOR REFERENCE ONLY.

 MARKING IS FOR PACKAGE ORIENTATION REFERENCE ONLY.

TITLE:
 PACKAGE OUTLINE, 6,8,10 & 14L,
 TDFN, EXPOSED PAD, 3x3x0.80 mm

APPROVAL	DOCUMENT CONTROL NO. 21-0137	REV. I 2/2
----------	---------------------------------	------------

—DRAWING NOT TO SCALE—

Bidirectional, High-Side, Current-Sense Amplifiers with Reference

Package Information (continued)

For the latest package outline information and land patterns, go to www.maxim-ic.com/packages.

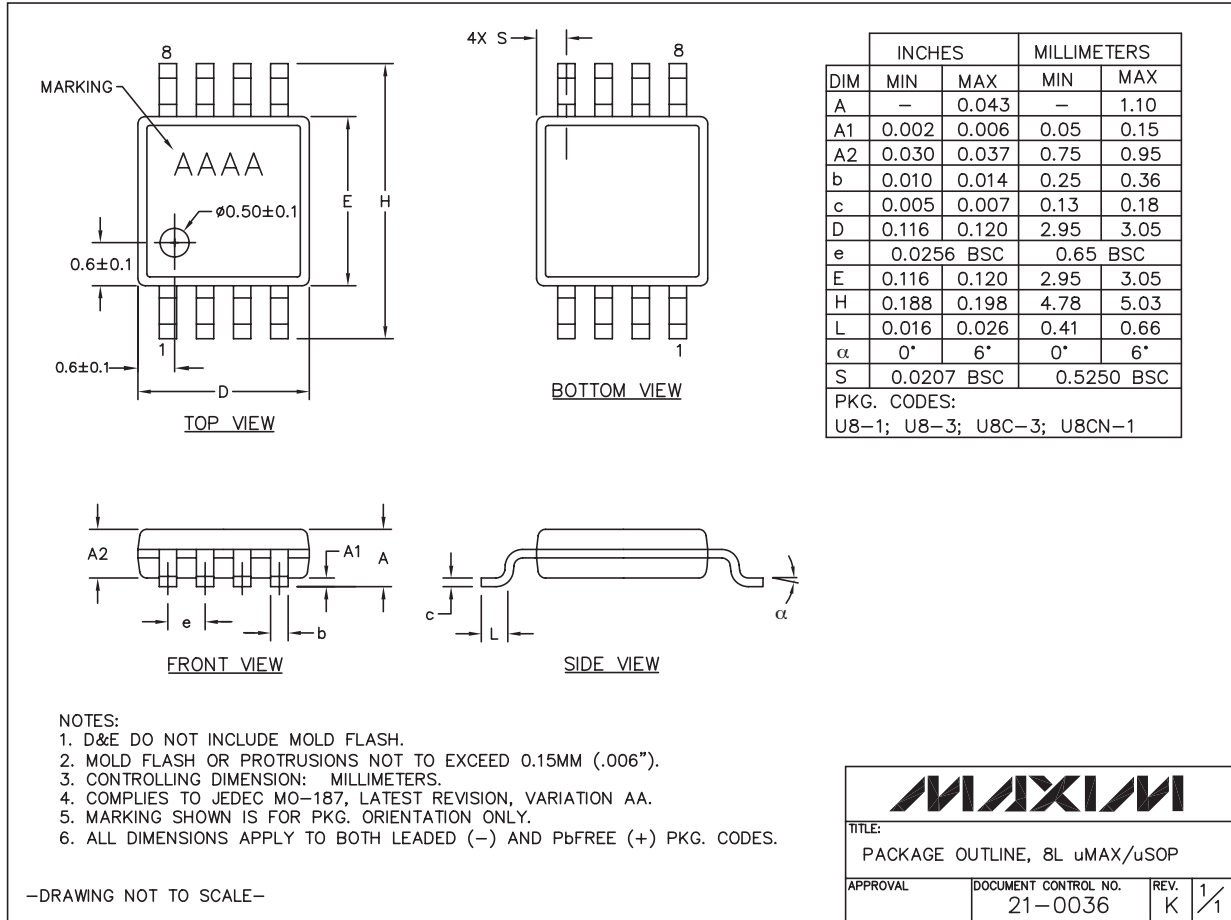

8LUMAXD.EPS



TITLE: PACKAGE OUTLINE, 8L μ MAX/ μ SOP		
APPROVAL	DOCUMENT CONTROL NO. 21-0036	REV. K 1/1

Bidirectional, High-Side, Current-Sense Amplifiers with Reference

Package Information (continued)

For the latest package outline information and land patterns, go to www.maxim-ic.com/packages.

MAX4069-MAX4072

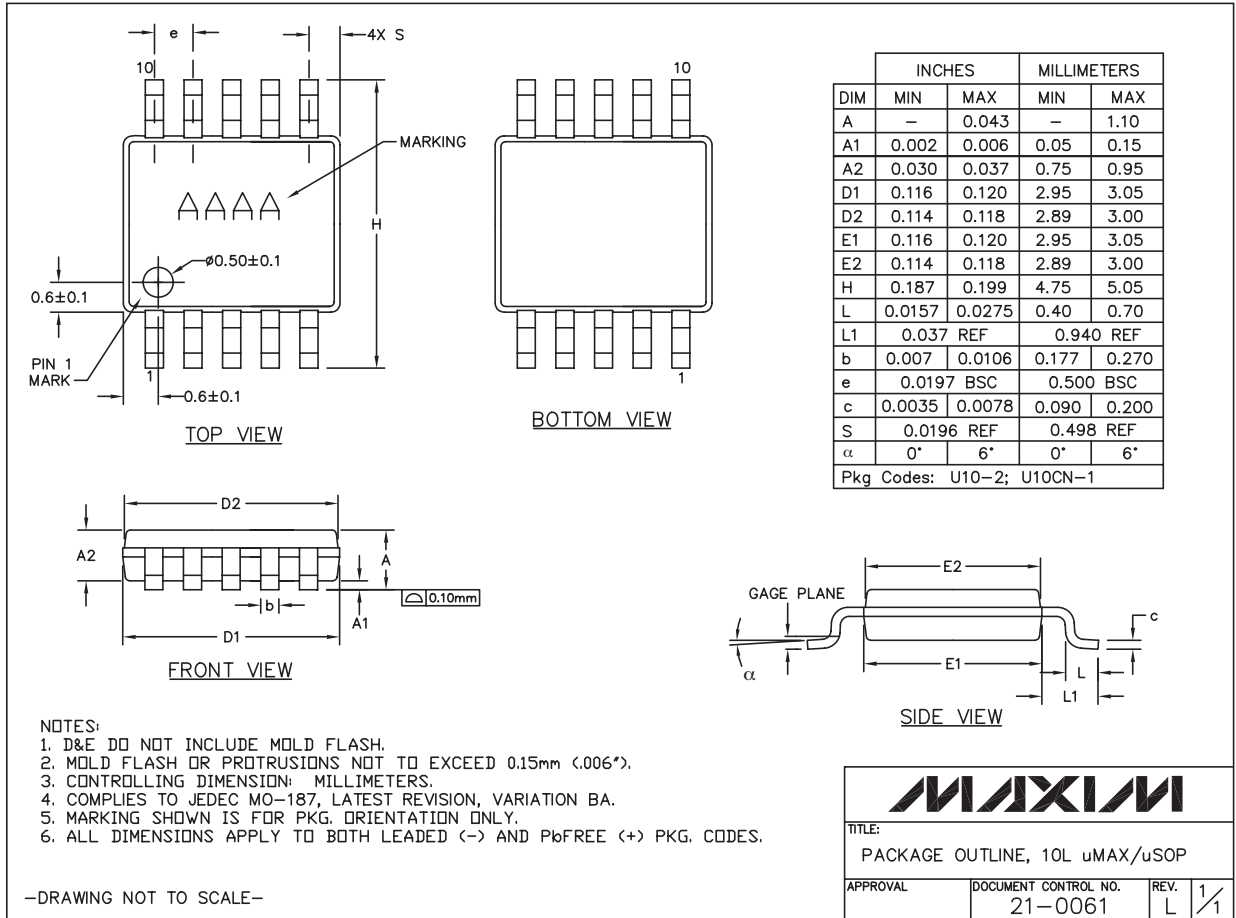

Bidirectional, High-Side, Current-Sense Amplifiers with Reference

Revision History

REVISION NUMBER	REVISION DATE	DESCRIPTION	PAGES CHANGED
3	11/08	Added information for RG1 and RG2	10

Maxim cannot assume responsibility for use of any circuitry other than circuitry entirely embodied in a Maxim product. No circuit patent licenses are implied. Maxim reserves the right to change the circuitry and specifications without notice at any time.

Maxim Integrated Products, 120 San Gabriel Drive, Sunnyvale, CA 94086 408-737-7600 _____ **18**